

## 抗磁场干扰电流互感器

CT immune to Magnetic field

### ► 产品特征:

- 采用高导磁率磁芯，精度高，线性度好；
- 带有电工纯铁屏蔽罩，保护互感器在受到外部磁场干扰下，仍可正常工作；
- 塑料外壳采用阻燃性材质；
- 环氧树脂浇注封装，绝缘能力强，抗震性能好；
- 符合抗直流分量要求；
- 使用广泛，主要用于电能表计量，设备仪器；
- 在线测试，漏电检测等。

### ► Features:

- Adopted high permeability core , high accuracy, good linear performance;
- CT with iron shield , immune to magnetic field;
- Anti-combustion plastics case;
- Encapsulated with epoxy resin with strong insulation ability;
- DC immunity function.

## 产品及外形尺寸图 Outline dimensions

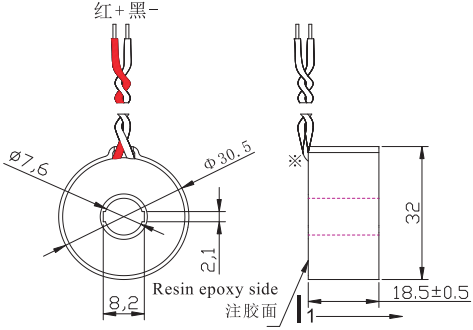
T-01	外形尺寸图 Outline dimension
	

## 常用规格及参数 Regular Specs and Parameters

Type 型号	Rated Primary Current(A) 额定初级电流(A)	Max. Current (A) 初级最大电流(A)	Secondary Current 额定次级电流(mA)	AC accuracy 交流精度等级	DC Error 直流精度等级	Against magnet field 抗磁场强度
T-01	5	20/40/60/80/100	2/2.5/5	0.05/0.1/0.2	1.0/2.0	200mT
	10	40/60/80/100/120	4/5/10	0.05/0.1/0.2	1.0/2.0	200mT
	15	60/80/100/120	5/6/7.5/15	0.05/0.1/0.2	1.0/2.0	200mT
	20	80/100/120	5/8/10/20	0.05/0.1/0.2		200mT

产品及外形尺寸图 Outline dimensions

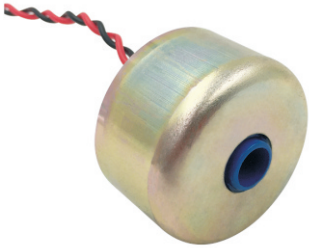
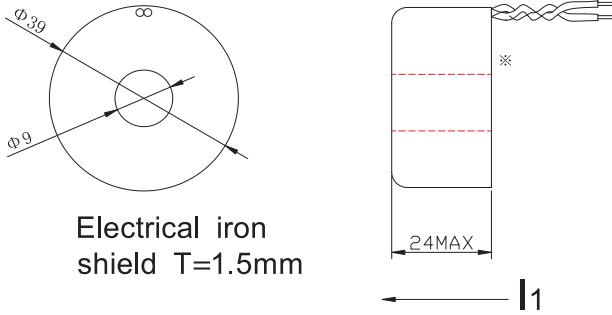
T-02	外形尺寸图 Outline dimension
	 <p>Electrical iron shield T=1.5mm</p>

常用规格及参数 Regular Specs and Parameters

Type 型号	Rated Primary Current(A) 额定初级电流(A)	Max. Current (A) 初级最大电流(A)	Secondary Current 额定次级电流(mA)	AC accuracy 交流精度等级	DC Error 直流精度等级	Against magnet field 抗磁场强度
T-02	5	20/40/60/80/100	2/2.5/5	0.05/0.1/0.2	1.0/2.0	350mT
	10	40/60/80/100/120	4/5/10	0.05/0.1/0.2	1.0/2.0	350mT
	15	60/80/100/120	5/6/7.5/15	0.05/0.1/0.2	1.0/2.0	350mT
	20	80/100/120	5/8/10/20	0.05/0.1/0.2		350mT

产品及外形尺寸图 Outline dimensions

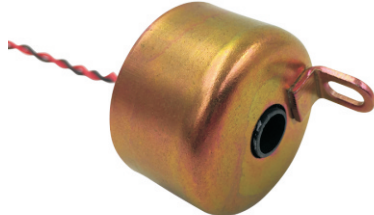
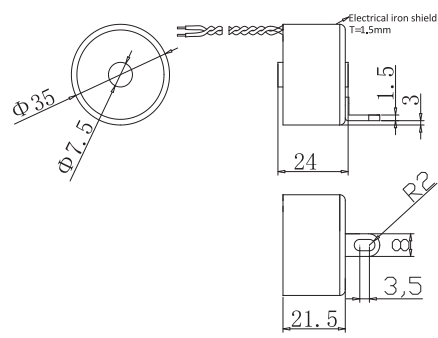
T-03	外形尺寸图 Outline dimension
	 <p>Electrical iron shield T=1.5mm</p>

常用规格及参数 Regular Specs and Parameters

Type 型号	Rated Primary Current(A) 额定初级电流(A)	Max. Current (A) 初级最大电流(A)	Secondary Current 额定次级电流(mA)	AC accuracy 交流精度等级	DC Error 直流精度等级	Against magnet field 抗磁场强度
T-03	5	20/40/60/80/100	2/2.5/5	0.05/0.1/0.2	1.0/2.0	350mT
	10	40/60/80/100/120	4/5/10	0.05/0.1/0.2	1.0/2.0	350mT
	15	60/80/100/120	5/6/7.5/15	0.05/0.1/0.2	1.0/2.0	350mT
	20	80/100/120	5/8/10/20	0.05/0.1/0.2		350mT

产品及外形尺寸图 Outline dimensions

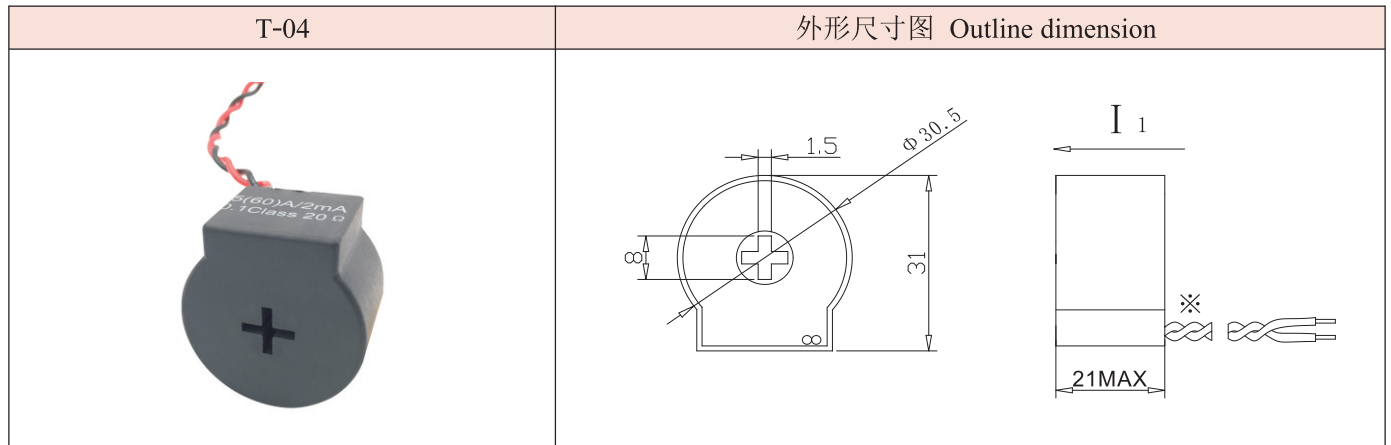

常用规格及参数 Regular Specs and Parameters

Type 型号	Rated Primary Current(A) 额定初级电流(A)	Max. Current (A) 初级最大电流(A)	Secondary Current 额定次级电流 (mA)	AC accuracy 交流精度等级	DC Error 直流精度等级	Against magnet field 抗磁场强度
T-04	5	20/40/60/80/100	2/2.5/5	0.05/0.1/0.2	1.0/2.0	200mT
	10	40/60/80/100/120	4/5/10	0.05/0.1/0.2	1.0/2.0	200mT
	15	60/80/100/120	5/6/7.5/15	0.05/0.1/0.2	1.0/2.0	200mT
	20	80/100/120	5/8/10/20	0.05/0.1/0.2		200mT